

Atlas Copco



Oil-injected rotary screw compressors

GA 30⁺-90/GA 37-110 VSD⁺ (30-110 kW/40-150 hp)



Innovating for a sustainable future

At Atlas Copco, we have always looked ahead. Which products and services will make our customers more successful? Your future drives the Atlas Copco team every day. It is the reason why we devote so much time and so many resources to innovation. If there are technologies that will advance your productivity, we will find them. That is what we have been doing for almost 150 years now, setting new standards in compressed air reliability, efficiency, connectivity, and sustainability.

It's that last principle that now comes first. Sustainability is no longer something we should strive for, but something we must achieve. Productivity and growth will have to be built on sustainability. Atlas Copco – our products, our services, and our people – will help you get there, as we always have.

The technology that drives sustainability



Smart Temperature Control System

Calculates and achieves the ideal oil-injection temperature based on actual operating conditions to maximize efficiency.



Intelligent sensors

Constantly monitor the pressure drop and thus any energy losses in the inlet filter, the oil separator, and the oil filter.



Energy recovery

Gives you additional energy savings by recovering and re-using up to 75% of the heat the compressor produces.



The ultimate smart solution, driven by efficiency



Atlas Copco's GA compressors bring you outstanding sustainability, reliability and performance, while minimizing total cost of ownership. A choice of three premium compressor types (GA VSD⁺, GA⁺ and GA) provides you with the compressed air solution that perfectly matches your requirements with clear value propositions. Built to perform even in the harshest environments, these compressors keep your production running efficiently.



GA 37-90 Premium compressor

- High-performance Free Air Delivery.
- Premium quality at the lowest initial investment.
- Integrated refrigerant dryer.
- Elektronikon® Touch or Swipe controller.
- **SMARTLINK** real-time, remote monitoring and optimization.



GA 30⁺-75⁺ Smart performance

- IE4 motor and high-efficiency element.
- In-house developed Smart Temperature Control System ensures oil temperature is always optimal to achieve maximum element efficiency and reliability (on GA 55⁺-75⁺).
- Low noise emission suitable for workplace installation.
- Integrated refrigerant dryer.
- Elektronikon Touch controller.
- **SMARTLINK** real-time, remote monitoring and optimization.
- OPC UA connectivity available.



GA 37L-110 VSD⁺ Ultimate energy saver

- Up to 50% energy savings compared to fixed-speed models.
- iPM motor exceeds IE5 standards.
- In-house designed Neos inverter and iPM motor exceed IES2 (EN 50598) requirements for power drive efficiency.
- Industry-leading operating turndown range.
- Wide pressure selection: 4-13 bar.
- Start under system pressure, no blow-off.
- Integrated refrigerant dryer.
- Elektronikon Touch controller.
- **SMARTLINK** real-time, remote monitoring and optimization.
- OPC UA connectivity available.

GA 37L-110 VSD+: Ultimate energy saver

When you are looking for efficiency, lowest cost of ownership and sustainability, the GA 37L-110 VSD+ delivers a superior solution. This oil-injected screw compressor with Variable Speed Drive technology generates energy savings of up to 50%. What is more, its upright, compact design saves valuable floor and workspace, eases maintenance access, and reduces total cost of ownership.

IE5

Meeting and exceeding efficiency benchmarks:

- The iPM motor of the GA 37L-110 VSD+ exceeds IE5 standards.
- Neos inverter and iPM motor exceed IE52 (EN 50598) requirements for power drive efficiency.

1

Interior Permanent Magnet (iPM) motor

- Oil-cooled motor.
- Optimal cooling for all speeds and ambient conditions.
- Designed in-house in Belgium.
- Oil-lubricated motor bearing: no (re)grease(ing), increased uptime.
- IP66: pressure-tight.

2

New compressor element

- New improved rotor profile.
- Reduced pressure losses.
- Optimized in and outlet portals.

3

Direct drive

- Vertical design, less parts.
- Oil-cooled, pressure-tight.
- No gears or belts, no shaft seal.

4

Inlet filter

- Heavy duty.
- Maintenance every 4,000 hours.
- Pressure drop indicator.

5

Electronic no-loss water drain

- Ensures constant removal of condensate.
- Manual integrated bypass for effective condensate removal in case of power failure.
- Integrated with compressor's Elektronikon with warning/alarm features.



6

High-tech fan

- Compact.
- Low noise level.
- High capacity for optimized cooling.
- Compliant with ERP2020 efficiency standards.

7

Classic cooler design

- Integrated water separation.
- Separate oil/air cooler.
- Easy access for maintenance.

8

Innovative Neos inverter

- Atlas Copco's in-house designed inverter also controls iPM motors.
- IP5x protection.
- Robust aluminum enclosure for trouble-free operation in the harshest conditions.
- Fewer components: compact, simple and user-friendly.

9

Integrated dryer

- Extra compact footprint.

10

Elektronikon Touch controller

- High-tech controller with warning indications, compressor shut-down and maintenance scheduling.
- Easy to use and designed to perform in the toughest conditions.
- Standard **SMARTLINK** remote monitoring to maximize air system performance and energy savings.
- Optional multiple compressor control (2, 4 or 6 compressors).

12

VSD+ Neos cubicle

- Electrical components remain cool, enhancing their lifetime.
- Dedicated drive for iPM technology motors.
- Heat dissipation of inverter in separate compartment.

11

Sentinel no-loss inlet valve

- Optimizes the inlet flow of the air end.
- No blow-off losses.
- Full aluminum design: maintenance-free (GA 37L-75 VSD+).

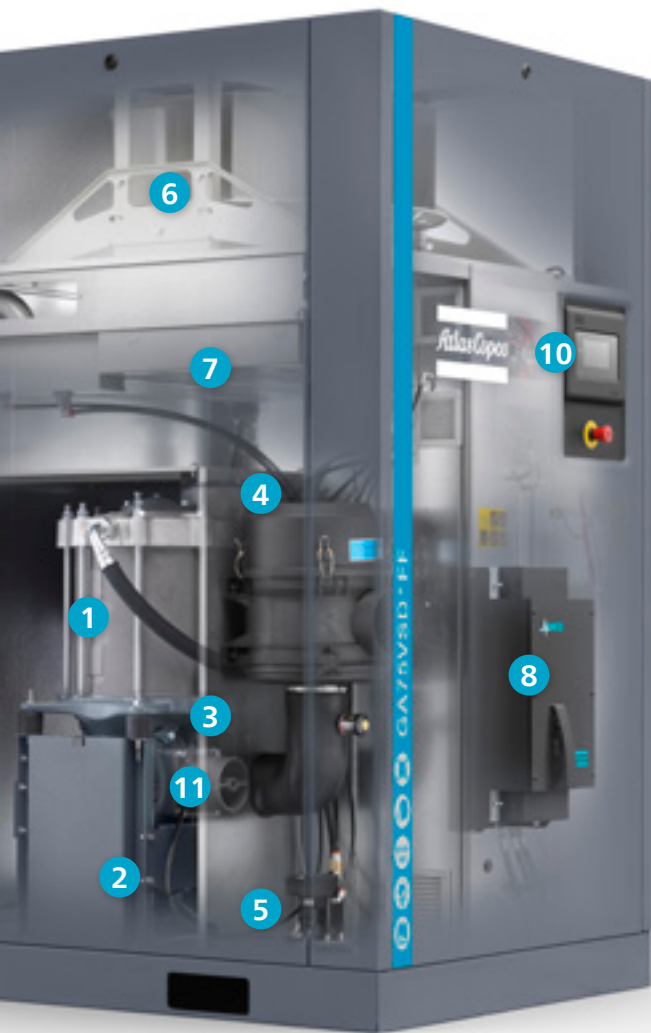



VSD+ for up to 50% energy savings*

Over 80% of a compressor's lifecycle cost is taken up by the energy it consumes. Moreover, the generation of compressed air can account for more than 40% of a plant's total electricity bill. To cut your energy costs, Atlas Copco pioneered Variable Speed Drive+ (VSD+) technology in the compressed air industry. VSD+ leads to major energy savings, while protecting the environment for future generations. Thanks to continual investments in this technology, Atlas Copco offers the widest range of integrated VSD+ compressors on the market.

Why Atlas Copco Variable Speed Drive+ technology?

- Up to 50% energy savings with an extensive flow range (20-100%).
- Integrated Elektronikon Touch controls the motor speed and high-efficiency frequency inverter.
- No wasted idling times or blow-off losses during operation.
- Compressor can start/stop under full system pressure without the need to unload.
- Eliminates peak current penalty during start-up.
- Minimizes system leakage due to a lower system pressure.
- EMC compliance to directives (2014/30/EU).

* Compared to fixed-speed compressors, based on measurement performed by an independent energy audit agency.

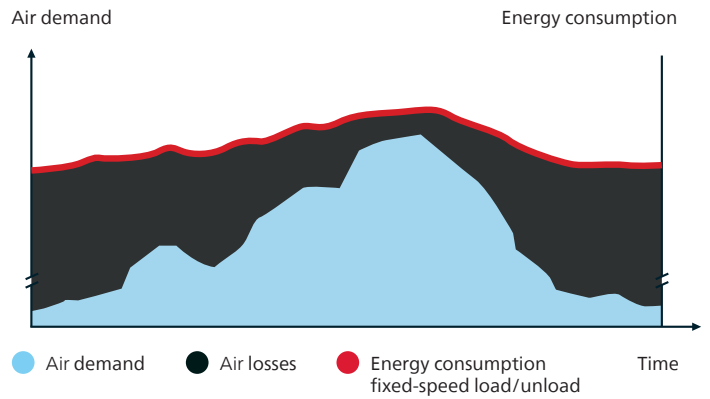

In almost every production environment, air demand fluctuates depending on different factors such as the time of the day, week or even month. Extensive measurements and studies of compressed air demand profiles show that many compressors have substantial variations in air demand.

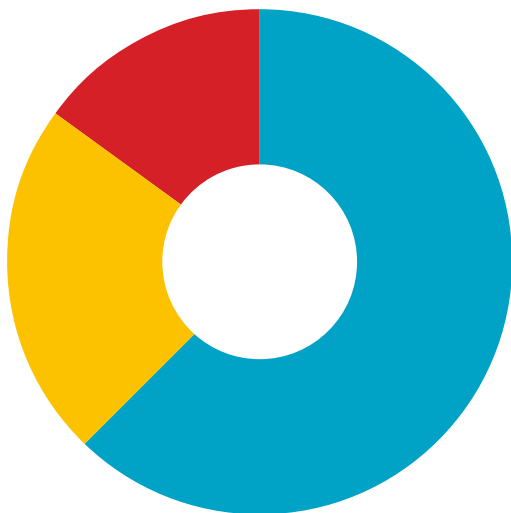
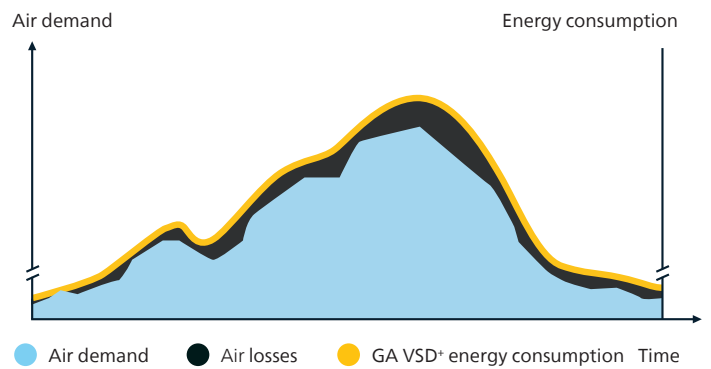

50%
SAVINGS

↑ ↓



● Investment ● Energy ● Maintenance

Up to 50% energy savings

Atlas Copco's GA VSD+ technology closely follows the air demand by automatically adjusting the motor speed. This results in up to 50% energy savings. In addition, lowered system pressure with GA VSD+ dramatically minimizes energy use across your production.

GA 30⁺-75⁺: Smart performance

The GA 30⁺-75⁺ is our fixed-speed oil-injected rotary screw compressor that sets the industry standard. It gives you more of the things that really matter: more energy savings, more air, and a longer lifetime. Its state-of-the-art compression element and a host of advanced features ensure maximum performance with best-in-class efficiency.

1

Maintenance-free drive system

- 100% maintenance-free; totally enclosed and protected against dirt and dust.
- No coupling or slippage losses.
- Standard up to 46°C/115°F; high ambient version 55°C/131°F.
- Works reliably in harsh environments.

New state-of-the-art hybrid bearings extend the lifetime of the drivetrain by 33% (GA 55⁺-75⁺).

2

IE4/NEMA Super Premium Efficiency motors

- IP55, insulation Class F, B rise.
- Oil-lubricated drive side bearings.
- Designed for continuous operation in harsh environments.

3

Robust spin-on oil filter

- High efficiency; removes 300% smaller particles than a conventional filter.
- Integrated bypass valve with the oil filter.
- 8,000-hour service interval (GA 55⁺/GA 75⁺).

4

(Smart) no-loss drain

- No-loss electronic drain on GA 30⁺-45⁺ monitors condensate build-up and removes liquid only when necessary to avoid air loss.
- Smart no-loss water drain on GA 55⁺-75⁺ with automatic removal of condensate, auto-cleaning, and detection of potential issues.





5 Smart Temperature Control System (GA 55+/GA 75+)

An intelligent algorithm calculates the ideal oil-injection temperature based on parameters such as ambient and oil temperature, pressure and load, and air humidity. When necessary, the STC valve routes the oil via the coolers to achieve that ideal temperature to increase compressor efficiency and eliminate the risk of condensation.



6 Intelligent sensors (GA 55+/GA 75+)

- Pressure drop sensors monitor the lifetime of the inlet filter, the oil separator, and the oil filter.
- CAN cables allow for easy updates.

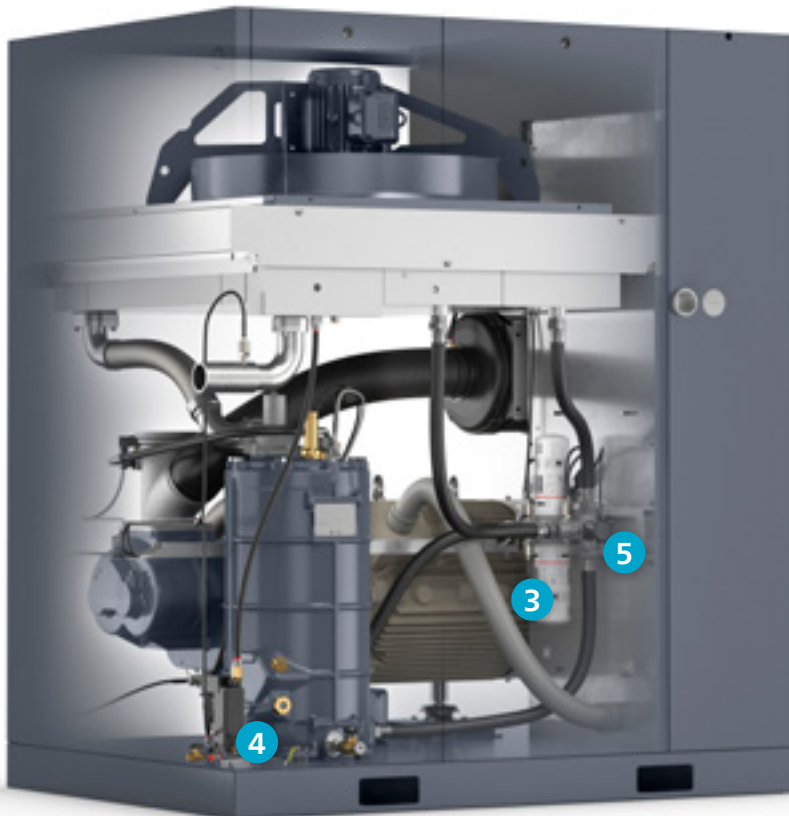

7 Elektronikon Touch for remote monitoring

- High-tech controller with warning indications, compressor shut-down and maintenance scheduling.
- Standard **SMARTLINK** remote monitoring to maximize air system performance and energy savings.

The smart unload algorithm monitors pressure fluctuations in real time to reduce the running time in unload and achieve maximum energy savings.

8 EQ2i

- Multiple compressor control integrated as standard.

9 Heavy-duty air intake filter

- Protects compressor components by removing 99.9% of dirt particles down to 3 microns.
- 8,000-hour lifetime (GA 55+/GA 75+).

GA 37-90: Premium compressor

The GA 37-90 gives you that trusted Atlas Copco oil-injected screw performance at the lowest investment cost. Built with top-quality materials, the GA 37-90 ensures compressed air reliability and efficiency in the toughest conditions.

1

Maintenance-free drive system

- 100% maintenance-free; totally enclosed and protected against dirt and dust.
- New state-of-the-art hybrid bearings extend the lifetime of the drive train by 33% (GA 55-90).
- No coupling or slippage losses.
- Standard up to 46°C/115°F and for high ambient version 55°C/131°F.

2

Super Premium Efficiency electrical motor

- IE4 efficiency motor (GA 55-90).
- IP55, insulation Class F, B rise.
- Non-drive side bearing greased for life.
- Oil-lubricated drive side bearings.
- Designed for continuous operation in harsh environments.

3

Robust spin-on oil filter

- High efficiency; removes 300% smaller particles than a conventional filter.
- Integrated bypass valve with the oil filter.

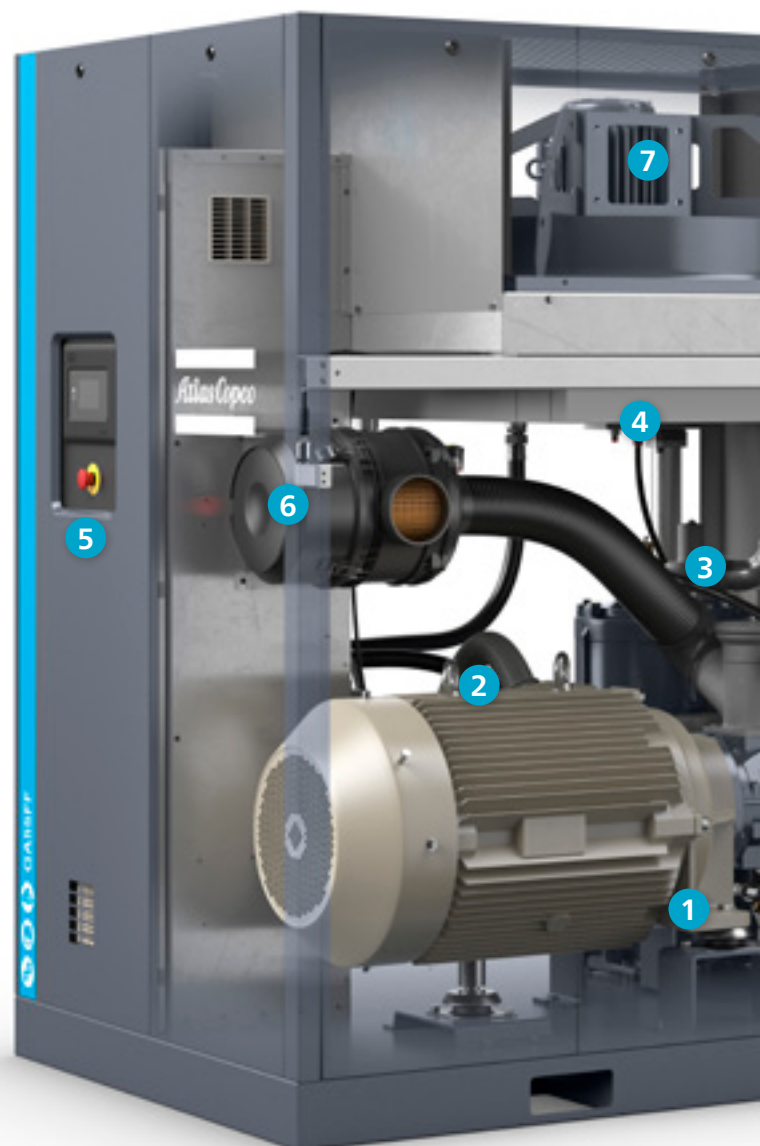

4

Oil cooler and aftercooler for tropical environments

- Low element outlet temperatures, ensuring long oil lifetime.
- Removal of nearly 100% of condensate by integrated mechanical separator.
- No consumables.
- Eliminates possibility of thermal shocks in coolers.



5

Advanced Elektronikon control & monitoring

- Easy to use and designed to perform in the toughest conditions.
- Monitoring features include warning indications, maintenance scheduling, and online visualization of machine conditions.
- Standard **SMARTLINK** remote monitoring to maximize air system performance and energy savings.

6

Heavy-duty air intake filter

- Protects the compressor components by removing 99.9% of dirt particles down to 3 microns.
- Differential inlet pressure for proactive maintenance while minimizing pressure drop.

7

Low noise fan

- Silent operation.
- High flows.
- Compact design.

8

Integrated dryer

- Excellence in air quality.
- 50% reduction in energy consumption compared to traditional dryers.
- Zero ozone depletion.
- Incorporates optional UD+ filter according to Class 1.4.2.

As connected as you will be

When it comes to connectivity, manufacturing equipment has long stayed behind. Not Atlas Copco. Our compressed air systems helped pave the way for Industry 4.0. We never stopped developing innovative features and introducing new options to help our customers meet their operational goals.

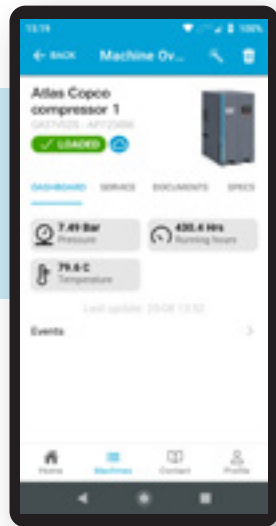

Connect

SMARTLINK

- Real-time monitoring of your compressor's operational parameters on your computer or mobile device.
- Performance data and insights identify opportunities for optimization.
- Service timeline.
- Maintenance and service alerts.
- Online resource center with manuals, documentation and technical information.



Control

Elektronikon Touch (optional for GA 37/GA 45)

The Elektronikon Touch features a 4.3-inch user-friendly, multilingual display with clear pictograms and a service indicator. The operating system offers a host of control and monitoring options and smart algorithms to optimize your compressor performance. Customized timers and efficiency controls are just a few examples.



Manage

Equalizer 4.0

Manage multiple compressors with the Equalizer 4.0 (integrated in your compressor or as a standalone unit):

- **Reduced pressure band:** Create a narrow, predefined pressure band to save energy.
- **Optimal system performance:** Program all compressors to have equal running hours to reduce service intervals.
- **Improve reliability and efficiency:** With actionable performance reports, service warnings, and energy efficiency data.
- **Multiple compressor control:** Manage up to 6 compressors in one air network. GA+ units come as standard with a built-in EQ2i, allowing the control of a second compressor.



Optimize

OPC UA

Atlas Copco was the first compressor manufacturer to offer OPC UA, the machine-to-machine communication protocol that was developed especially for industrial automation. That means you can integrate your Atlas Copco compressor seamlessly in your production network:

- Standardization of production equipment communication.
- Insight into production system performance and optimization options.
- Network security thanks to various encryption levels, authentication, auditing, and user control to ensure security.

Built-in quality air

Untreated compressed air contains moisture and aerosols that increase the risk of corrosion and compressed air system leaks. This can result in a damaged air system and contaminated end products. An air dryer is therefore essential to protect your systems and processes. The GA, GA+ and GA VSD+ compressors have an integrated dryer option to ensure your peace of mind.

Integrated dry air

- Optimized sizing for the compressor, avoiding excessive energy consumption.
- New oversized dryer option to ensure a low PDP in the toughest conditions (GA 55-90/ GA 55+-75+).
- Fit for your application.
- Controlled and monitored by the Elektronikon.
- Space-saving all-in-one solution with low installation costs.

Lowest lifecycle costs and peace of mind

- No extra installation costs.
- Save on floor space.
- Use of energy-efficient, environmentally friendly refrigerant reduces operating costs and stands for zero ozone depletion.
- Heat exchanger cross-flow technology with low pressure drop, saving energy and costs.
- Zero waste of compressed air thanks to no-loss condensate drain.
- Advanced control functions ensure dry air under all circumstances and prevent freezing at low load.
- Pressure dewpoint of 3°C/37°F (at 20°C/68°F).

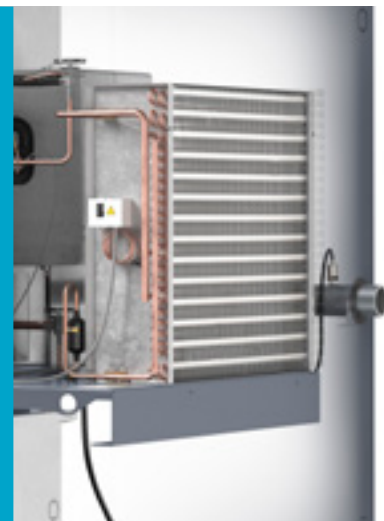

Integrated purity

The optional UD+ filter and integrated refrigerant air dryer (IFD) efficiently remove moisture, aerosols and dirt particles to protect your investment. The UD+ filter has a 40% lower pressure drop than the conventional DD+/PD+ filter combination. It saves space and reduces energy costs. Using only 1 single filter it is possible to reach Quality Class 1.4.2 according to ISO 8573-1:2010.

	ISO QUALITY CLASS*	DIRT PARTICLE SIZE	WATER PRESSURE DEWPOINT**	OIL CONCENTRATION
Pack compressor	3.-.4	5 microns	-	3 ppm
Integrated refrigerant dryer	3.4.4	5 microns	+3°C/37°F	3 ppm
DD+	2.4.2	1 micron	+3°C/37°F	0.1 ppm
UD+	1.4.2	0.5 micron	+3°C/37°F	0.1 ppm

* The table values reflect the maximum limits according to the ISO quality air standard (ISO 8573-1:2010).

** Water pressure dewpoint based on 100% RH at 20°C/68°F.

Built-in energy recovery

All electrical energy used by a compressed air system is converted into heat. Why let that heat go to waste? A specifically developed energy recovery system can be built into your GA, GA⁺, and GA VSD⁺, allowing you to recover up to 75% of that power input as hot air or hot water (e.g.: changing room showers). Through efficient use of the recovered energy, you generate important energy cost savings and a high return on investment without compromising your compressor's performance.

Use your compressor twice

Hot water

Convert compressor heat into hot water for:

- Radiators
- Laundries, industrial cleaning and sanitary facilities
- Industrial process heating
- Canteens and large kitchens
- Food, chemical and pharmaceutical industries



Ducting

Recovered hot air can be used for:

- Auxiliary or main heating of warehouses and workshops
- Drying processes



Optimize your system

Some applications may need or may benefit from additional options and more refined control/air treatment systems. To meet these needs, Atlas Copco has developed options and easily integrated compatible equipment.

		GA 37-45	GA 55-90	GA 30*	GA 37*-45+	GA 55*-75+	GA 37L-110 VSD*
Air treatment	UD+ filter*	•	•	•	•	•	•
	Oversized dryer*	-	•	-	-	•	-
	Dryer bypass*	-	•	-	-	•	-
Condensate	Electronic water drain	-	•	Standard	Standard	Standard	Standard
Protection	Pre-filter	•	•	•	•	•	•
	Heavy duty inlet filter	Standard	Standard	Standard	Standard	Standard	Standard
	High ambient version (55°C/131°F)****	•	•	•	•	•	•
	Tropical thermostat	•	•	•	•	STC	•
	Freeze protection	-	•	-	•	•	-
	Water shut-off valve**	-	•	-	•	•	•
	Anti-condensation heaters	-	•	-	•	•	-
	Phase sequence relay	-	•	-	-	•	-
	Nema4	-	•	-	•	•	-
	Nema4x	-	•	-	•	•	-
	Oil containing frame	•	•	•	•	•	-
	Rain protection	•	•	•	•	•	-
Communication	OPC UA	-	-	-	•	•	•
	Elektronikon controller expansion module	•	•	•	•	•	•
	Elektronikon Touch upgrade	•	Standard	Standard	Standard	Standard	Standard
	ES 100 relay***	-	Standard	-	•	Standard	-
	EQ2i	•	•	•	•	Standard	•
	EQ4i, EQ6i	•	•	•	•	•	•
Oils	RS Foodgrade Ultra oil	•	•	•	•	•	•
	Roto Synthetic xtend oil	•	•	•	•	Standard	•
General options	Water-cooled version	-	•	-	•	•	•
	Energy Recovery	•	•	•	•	•	•
	Power duct fan	•	•	•	•	•	•
	Oversized motor*****	-	•	-	-	•	-
	Advanced service monitoring	-	•	-	-	Standard	-
	Modulating control	-	•	-	•	•	-
	ANSI Flange	•	•	•	•	•	-
	DIN Flange	•	•	•	•	•	-
	IT ancilleries	-	-	-	-	-	•
	Test certificate	•	•	•	•	•	•
Public works	Lifting device	•	•	•	•	•	-
	Main switch	-	•	-	•	•	-

* FF units only.

** Water-cooled units.

*** Includes potential-free contacts: motor running, compressor load/unload.

**** FF units limited to 50°C/122°F on some models.

***** 55-75 kW only.

• : Optional - : Not available

Variable Speed Drive: GA VSD+

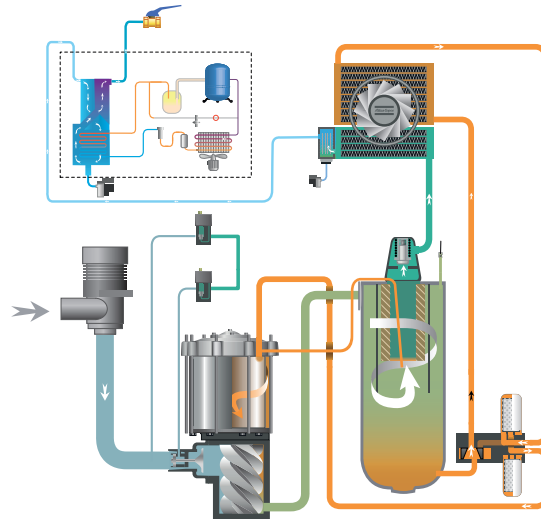

- Compressed air without free water
- Wet compressed air
- Condensate
- Dry compressed air
- Intake air
- Air/oil mixture
- Oil

Fixed-speed: GA+

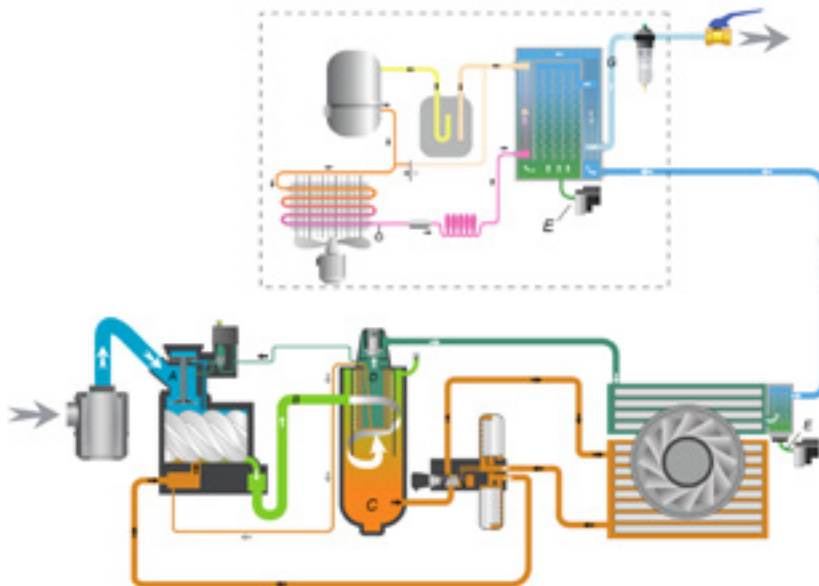

- A ● Intake air
- B ● Air/oil mixture
- C ● Oil
- D ● Hot compressed air
- E ● Condensate
- F ● Cooled compressed air
- G ● Dried compressed air

Fixed-speed: GA

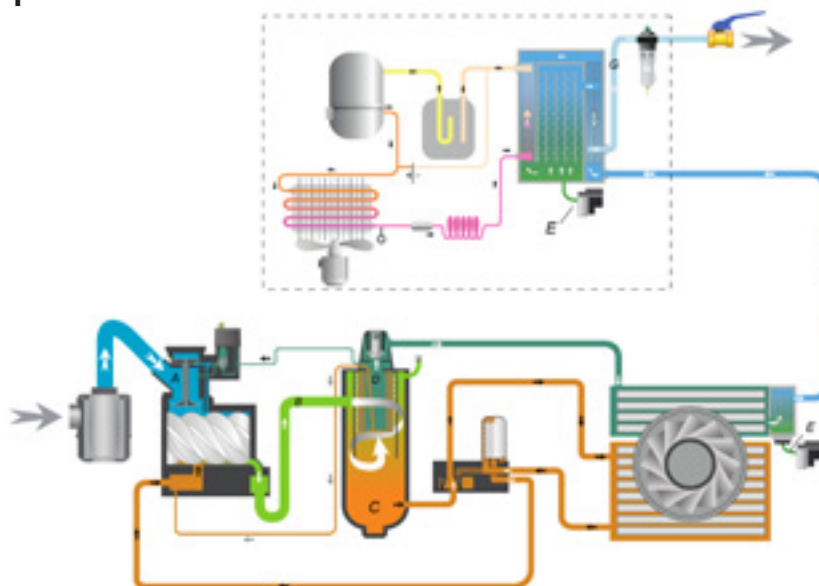

- A ● Intake air
- B ● Air/oil mixture
- C ● Oil
- D ● Hot compressed air
- E ● Condensate
- F ● Cooled compressed air
- G ● Dried compressed air

Technical specifications GA 30+-90 (50 Hz versions)

Compressor type	Pressure variant	Max. working pressure Pack		Capacity FAD*			Installed motor power		Noise level**	Weight Pack		Weight Full Feature	
		bar(e)	psig	l/s	m ³ /hr	cfm	kW	hp	dB(A)	kg	lbs	kg	lbs
GA 30+	7.5	7.5	109	99	357	210	30	40	66	626	1380	796	1755
	8.5	8.5	123	90	325	191	30	40	66	626	1380	796	1755
	10	10	145	83	297	175	30	40	66	626	1380	796	1755
GA 37	7.5	7.5	109	116	416	245	37	50	67	683	1506	853	1881
	8.5	8.5	123	108	388	228	37	50	67	683	1506	853	1881
	10	10	145	100	361	212	37	50	67	683	1506	853	1881
GA 37+	7.5	7.5	109	126	452	266	37	50	67	777	1713	943	2079
	8.5	8.5	123	119	427	251	37	50	67	777	1713	943	2079
	10	10	145	107	385	227	37	50	67	777	1713	943	2079
GA 45	7.5	7.5	109	138	497	293	45	60	68	692	1526	900	1984
	8.5	8.5	123	128	459	270	45	60	68	692	1526	900	1984
	10	10	145	119	430	253	45	60	68	692	1526	900	1984
GA 45+	7.5	7.5	109	151	543	320	45	60	68	808	1781	978	2156
	8.5	8.5	123	144	519	306	45	60	68	808	1781	978	2156
	10	10	145	131	472	278	45	60	68	808	1781	978	2156
GA 55	7.5	7.5	109	179	643	378	55	75	71	1360	2998	1685	3715
	8.5	8.5	123	171	614	362	55	75	71	1360	2998	1685	3715
	10	10	145	152	546	321	55	75	71	1360	2998	1685	3715
GA 55+	7.5	7.5	109	191	688	405	55	75	69	1365	3009	1690	3726
	8.5	8.5	123	181	650	383	55	75	69	1365	3009	1690	3726
	10	10	145	167	600	353	55	75	69	1365	3009	1690	3726
GA 75	7.5	7.5	109	229	825	486	75	100	73	1470	3241	1800	3968
	8.5	8.5	123	220	792	466	75	100	73	1470	3241	1800	3968
	10	10	145	203	730	430	75	100	73	1470	3241	1800	3968
GA 75+	7.5	7.5	109	257	924	544	75	100	71	1480	3263	1805	3979
	8.5	8.5	123	237	853	502	75	100	71	1480	3263	1805	3979
	10	10	145	218	784	462	75	100	71	1480	3263	1805	3979
GA 90	7.5	7.5	109	292	1052	619	90	125	72	1520	3351	1845	4068
	8.5	8.5	123	277	998	588	90	125	72	1520	3351	1845	4068
	10	10	145	256	923	543	90	125	72	1520	3351	1845	4068
	13	13	189	216	779	458	90	125	72	1520	3351	1845	4068

* Unit performance measured according to ISO 1217, Annex C, Edition 4:2009.

** A-weighted emission sound pressure level at the work station, Lp WSA (re 20 µPa) dB (with uncertainty 3 dB).

Values determined according to noise level test code ISO 2151 and noise measurement standard ISO 9614.

FAD is measured at the following working pressures:

- 7.5 bar versions at 7 bar
- 8.5 bar versions at 8 bar
- 10 bar versions at 9.5 bar
- 13 bar versions at 12.5 bar

Reference conditions:

- Absolute inlet pressure 1 bar (14.5 psi)
- Intake air temperature 20°C/68°F

Pressure dewpoint of integrated refrigerant dryer at reference conditions:

2°C to 3°C, 36°F to 37°F

Dimensions

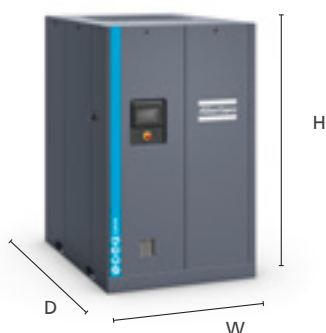

Dimensions	Pack						Full Feature					
	D (mm)	W (mm)	H (mm)	D (in)	W (in)	H (in)	D (mm)	W (mm)	H (mm)	D (in)	W (in)	H (in)
GA 30-45/30+-45*	1310	890	1790	51.57	35.04	70.47	1810	890	1790	71.26	35.04	70.47
GA 55+/75+/55/75/90	1680	1221	1980	66.14	48.07	77.95	2525	1221	1980	99.41	48.07	77.95
GA 37L-75 VSD*	1100	1153	1968	43.31	45.39	77.48	1100	1656	1968	43.31	65.20	77.48
GA 75L-110 VSD*	1400	1300	1968	55.12	51.18	77.48	2178	1300	1968	85.75	51.18	77.48

Technical specifications GA 30+-90 (60 Hz versions)

Compressor type	Pressure variant	Max. working pressure Pack		Capacity FAD*			Installed motor power		Noise level**	Weight Pack		Weight Full Feature	
		bar(e)	psig	l/s	m ³ /hr	cfm	kW	hp		kg	lbs	kg	lbs
GA 30+	100	7.4	107	101	364	214	30	40	66	643	1418	813	1792
	125	9.1	132	92	329	194	30	40	66	643	1418	813	1792
	150	10.8	157	83	298	176	30	40	66	643	1418	813	1792
GA 37	100	7.4	107	117	423	249	37	50	67	698	1539	868	1914
	125	9.1	132	107	387	228	37	50	67	698	1539	868	1914
	150	10.8	157	98	354	209	37	50	67	698	1539	868	1914
GA 37+	100	7.4	107	124	445	262	37	50	67	777	1713	943	2079
	125	9.1	132	113	405	239	37	50	67	777	1713	943	2079
	150	10.8	157	103	371	219	37	50	67	777	1713	943	2079
GA 45	100	7.4	107	139	502	295	45	60	68	745	1642	915	2017
	125	9.1	132	130	466	275	45	60	68	745	1642	915	2017
	150	10.8	157	118	426	250	45	60	68	745	1642	915	2017
GA 45+	100	7.4	107	151	543	319	45	60	68	808	1781	978	2156
	125	9.1	132	139	501	295	45	60	68	808	1781	978	2156
	150	10.8	157	131	471	277	45	60	68	808	1781	978	2156
GA 55	100	7.4	107	182	654	385	55	75	71	1360	2998	1685	3715
	125	9.1	132	167	601	354	55	75	71	1360	2998	1685	3715
	150	10.8	157	156	562	331	55	75	71	1360	2998	1685	3715
GA 55+	100	7.4	107	193	694	409	55	75	69	1365	3009	1690	3726
	125	9.1	132	180	648	381	55	75	69	1365	3009	1690	3726
	150	10.8	157	163	587	346	55	75	69	1365	3009	1690	3726
GA 75	100	7.4	107	233	838	493	75	100	73	1470	3241	1800	3968
	125	9.1	132	222	800	471	75	100	73	1470	3241	1800	3968
	150	10.8	157	201	724	426	75	100	73	1470	3241	1800	3968
GA 75+	100	7.4	107	256	922	543	75	100	71	1480	3263	1805	3979
	125	9.1	132	237	853	502	75	100	71	1480	3263	1805	3979
	150	10.8	157	212	763	449	75	100	71	1480	3263	1805	3979
GA 90	100	7.4	107	301	1082	637	90	125	72	1520	3351	1845	4068
	125	9.1	132	278	1000	588	90	125	72	1520	3351	1845	4068
	150	10.8	157	249	897	528	90	125	72	1520	3351	1845	4068
	175	12.5	181	223	803	472	90	125	72	1520	3351	1845	4068

Footnotes, reference conditions and FAD details of the 50 Hz versions.

Technical specifications GA 37L-110 VSD+

Compressor type	Max. working pressure		Capacity FAD* (min-max)			Installed motor power		Noise level**	Weight Pack	Weight Full Feature
	bar(e)	psig	l/s	m ³ /h	cfm	kW	hp			
GA 37L VSD+	4	58	26-133	94-479	55-282	37	50	67	860	1060
	7	102	26-132	93-475	55-279	37	50	67	860	1060
	9.5	138	25-116	89-418	53-246	37	50	67	860	1060
	12.5	181	38-99	138-355	81-209	37	50	67	860	1060
GA 45 VSD+	4	58	26-159	94-573	55-337	45	60	67	860	1060
	7	102	26-157	93-565	55-332	45	60	67	860	1060
	9.5	138	25-137	89-494	53-291	45	60	67	860	1060
GA 55 VSD+	12.5	181	38-115	138-359	81-211	45	60	67	860	1060
	4	58	26-189	93-680	55-400	55	75	67	900	1100
	7	102	26-188	94-677	55-399	55	75	67	900	1100
GA 75 VSD+	9.5	138	26-166	93-598	55-352	55	75	67	900	1100
	12.5	181	40-140	145-504	85-297	55	75	67	900	1100
	4	58	26-226	93-815	55-480	75	100	70	920	1120
GA 75L VSD+	7	102	27-225	97-809	57-476	75	100	70	920	1120
	9.5	138	27-198	96-712	57-419	75	100	70	920	1120
	12.5	181	42-167	150-600	88-353	75	100	70	920	1120
GA 90 VSD+	4	58	47-269	169-967	100-569	75	100	73	1207	1496
	7	102	48-266	172-957	101-563	75	100	73	1207	1496
	9.5	138	58-235	210-847	124-498	75	100	73	1207	1496
GA 110 VSD+	12.5	181	70-194	252-699	149-411	75	100	73	1207	1496
	4	58	48-311	174-1121	102-660	90	125	74	1213	1503
	7	102	49-306	176-1101	104-648	90	125	74	1213	1503
GA 110 VSD+	9.5	138	60-269	215-969	127-570	90	125	74	1213	1503
	12.5	181	71-218	255-784	150-461	90	125	74	1213	1503
	4	58	47-348	170-1251	100-736	110	150	76	1222	1573
GA 110 VSD+	7	102	49-345	175-1241	103-731	110	150	76	1222	1573
	9.5	138	59-309	211-1111	124-654	110	150	76	1222	1573
	12.5	181	71-268	254-965	150-568	110	150	76	1222	1573

* Unit performance measured according ISO 1217 ed. 4 2009, annex E, latest edition.

** Mean noise level measured at a distance of 1 m at max. working pressure according to ISO 2151: 2004 using ISO 9614/2 (sound intensity method); tolerance 3 dB(A).

Maximum working pressure:
13 bar(e) (188 psig)



ISO 9001 • ISO 14001
OHSAS 18001

Atlas Copco

atlascopco.com

